

Bestimmung der Schweißkraft von flüssigen/konsistenten Schmierstoffen nach IP 239/85

Belastung/load:	6 kg - 800 kg
Temperatur/temperature:	Eigenerwärmung/ <i>self heating</i>
Drehzahl/number of revolutions:	1450 +/- 50 Upm./rpm.
Prüfdauer/testing period:	60 sec.

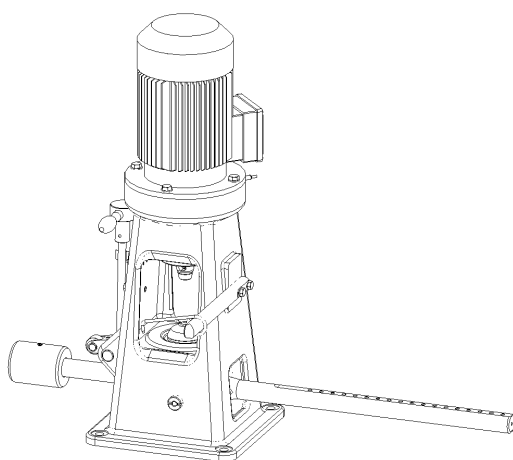

1 Stück Vierkugelapparat Grundgerät Motordrehzahl 1500min⁻¹
4-ball VKA 110 luboil tester - Engine speed 1500 rpm.

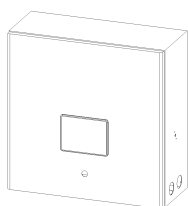

1 Stück Steuer und Überwachungsgerät Art.Nr. 00000152
Control and monitoring unit

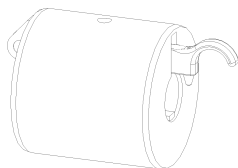

1 Stück Laufgewicht 10 kg komplett Art.Nr. VKA - 30
Jockey weight 10.0 kg compl

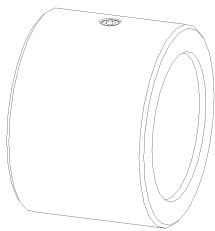

1 Stück

Zusatzgewicht 10 kg
Additional weight, 10.0 kg

Art.Nr. VKA – 36

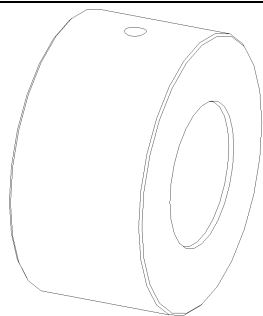

1 Stück

Zusatzgewicht 30 kg
Additional weight, 30.0 kg

Art.Nr. VKA – 100

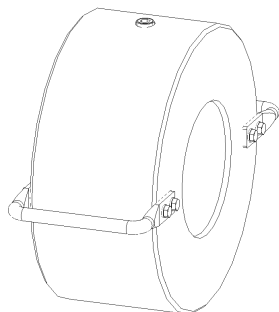

1 Stück

Zusatzgewicht 40 kg
Additional weight, 40.0 kg

Art.Nr. VKA – 37

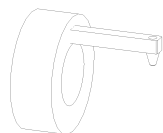

1 Stück

Laufgewicht 1 kg
Jockey weight 1.0 kg

Art.Nr. VKA – 51

Geschäftsführer: Jan Rohde
Monika Rohde

Dresdner Bank Hamburg
BLZ 200 800 00 – Kto.-Nr. 05014 840 00
S.W.I.F.T. Code: DRES DE FF 200
IBAN DE29 2008 0000 0501 4840 00

Postbank Hamburg
BLZ 200 100 20 – Kto.-Nr. 43107-205
Ust.-IDNr. DE 118 560 989
St.-Nr. 54 840 00648

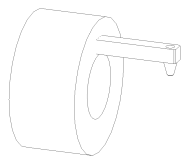

1 Stück

Laufgewicht 2 kg
Jockey weight 2.0 kg

Art.Nr. VKA – 52

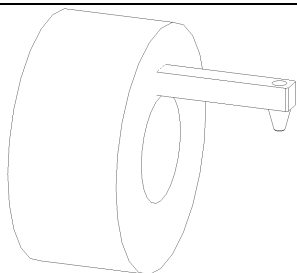

1 Stück

Laufgewicht 2,5 kg
Jockey weight 2.5 kg

Art.Nr. VKA – 53

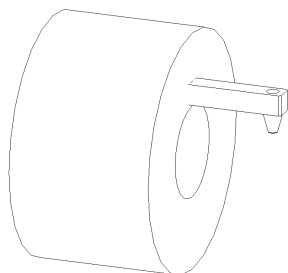

1 Stück

Laufgewicht 5 kg
Jockey weight 5.0 kg

Art.Nr. VKA – 54

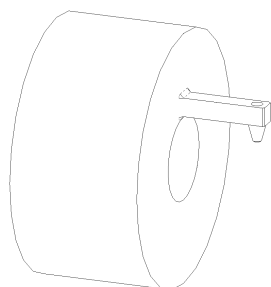

1 Stück

Laufgewicht 7 kg
Jockey weight 7.0 kg

Art.Nr. VKA – 99

Geschäftsführer: Jan Rohde
Monika Rohde

Dresdner Bank Hamburg
BLZ 200 800 00 – Kto.-Nr. 05014 840 00
S.W.I.F.T. Code: DRES DE FF 200
IBAN DE29 2008 0000 0501 4840 00

Postbank Hamburg
BLZ 200 100 20 – Kto.-Nr. 43107-205
Ust.-IDNr. DE 118 560 989
St.-Nr. 54 840 00648

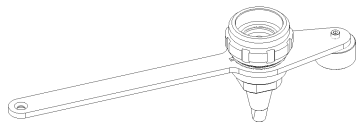

1 Stück

Kugeltopf Standard
Standard ball cup

Art.Nr. 00000135



1 Stück

Kugelhalter
Ball holder

Art.Nr. 00000021

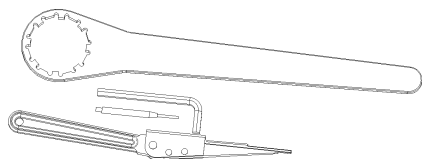

1 Satz

Werkzeug
Tools